

PRECIOUS

LOVE
CERAMIC TILES

LOVE
CERAMIC TILES

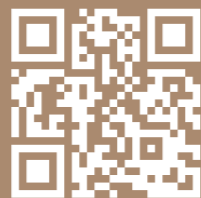

PRECIOUS
CALACATTA

MATT AND BRIGHT

MATE E BRILHO // MAT ET BRILLANT // MATT UND GLÄNZEND // МАТОВАЯ И ГЛЯНЦЕВАЯ

35X100 RET. // 35X70 RET.

SMOOTH AND POLISHED

AMACIADO E POLIDO // SATINÉ ET POLI // WEICH UND POLIERT // ГЛАДКАЯ И ПОЛИРОВАННАЯ

59,2X59,2 RET.

PRECIOUS MOMENTS

PRECIOUS são os momentos que vivemos apaixonadamente no conforto da nossa casa.

PRECIOUS are the moments we passionately live at the comfort of our home

PRECIOUS ce sont les moments que nous vivons avec passion, confortablement chez nous.

PRECIOUS sind die Momente, die wir leidenschaftlich im Komfort unseres Heims erleben.

PRECIOUS это моменты, когда мы наслаждаемся теплом и уютом нашего дома.

LOVE
CERAMIC TILES

PRECIOUS
CALACATTA



LOVE
CERAMIC TILES



PRECIOUS

LOVE
CERAMIC TILES

PRECIOUS CALACATTA POL. 59,2X59,2 RET.



PRECIOUS CALACATTA 35X100 RET. // BELOVED CALACATTA 35X100 RET. // PRECIOS CALACATTA POL. 59,2X59,2 RET.



PRECIOUS CALACATTA MATT 35X70 RET. // BOXY CALACATTA 35X70 RET. // PRECIOUS CALACATTA AMA. 59,2X59,2 RET.



PRECIOUS

LOVE
CERAMIC TILES



CURL CALACATTA MATT 35X70 RET.



PRECIOUS CALACATTA MATT 35X70 RET. // CURL CALACATTA MATT 35X70 RET. // PRECIOUS CALACATTA AMA. 59,2X59,2 RET.



PRECIOS CALACATTA 35X100 RET. // PRECIOS CALACATTA AMA. 59,2X59,2 RET.



PRECIOUS CALACATTA 35X100 RET.



35X100 RET. // 35X70 RET. // 59,2X59,2 RET.

PRECIOUS

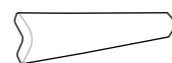

- ✕ PERFIL PRECIOUS CALACATTA
1,7X50 P-6280
1,7X35 P-6220
- PERFIL PRECIOUS CALACATTA MATT
1,7X50 P-6280
1,7X35 P-6220



- RODAPÉ PRECIOUS CALACATTA POL.
8X59,2 RET. P-6090
- RODAPÉ PRECIOUS CALACATTA AMA.
8X59,2 RET. P-6090

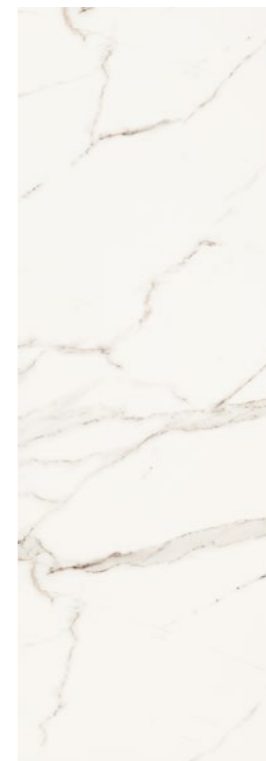

- ✕ CALACATTA
35X100 RET. LM-3660
35X70 RET. LM-3505

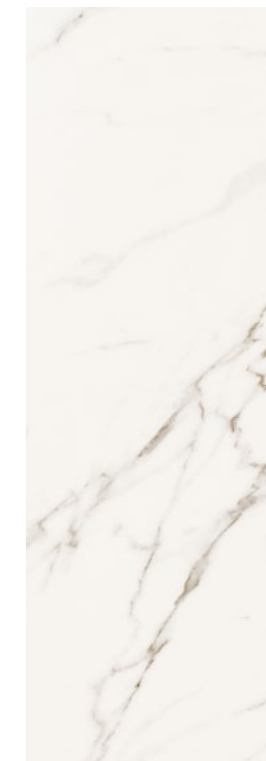

- CALACATTA MATT
35X100 RET. LM-3660
35X70 RET. LM-3505

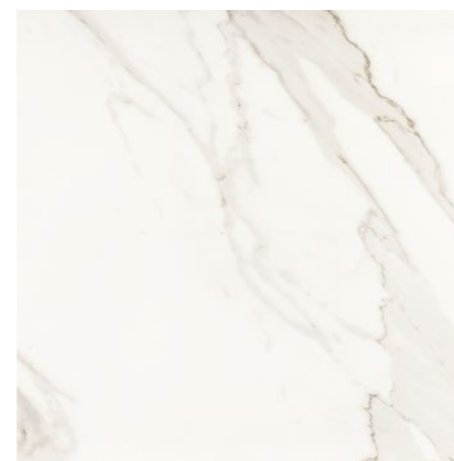

- ✕ CALACATTA POL.
59,2X59,2 RET. LM-3545

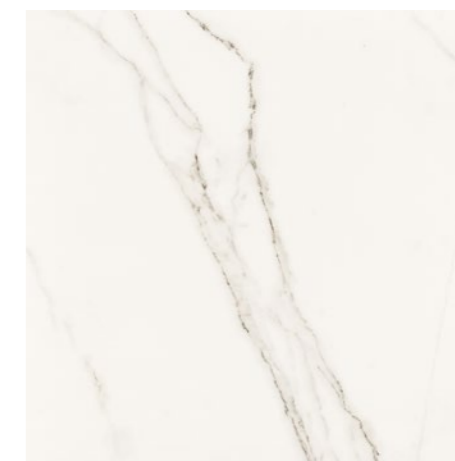

- ✕ CALACATTA AMA.
59,2X59,2 RET. LM-3545





35X100 RET. // 35X70 RET.



35X100 RET. // 35X70 RET.



× SHAPE CALACATTA
35X100 RET.

LM-3705



× SHAPE CALACATTA MATT
35X100 RET.

LM-3705



× FLOW CALACATTA
35X100 RET.

LM-3705



× FLOW CALACATTA MATT
35X100 RET.

LM-3705



× SUPERB CALACATTA
35X100 RET.

P-6480



× SUPERB CALACATTA MATT
35X100 RET.

P-6480



× GORGEOUS CALACATTA
35X100 RET.

P-6460



× BELOVED CALACATTA
35X100 RET.

LM-3705



× CURL CALACATTA
35X70 RET.

LM-3545



× CURL CALACATTA MATT
35X70 RET.

LM-3545



× LISTELO PRECIOS
5X100

P-6310



× LISTELO PRECIOS
3X70

P-6200



× LISTELO GOLD
1,5X35

P-6240



× SUPERB CALACATTA
35X70 RET.

P-6450



× SUPERB CALACATTA MATT
35X70 RET.

P-6450



× BOXY CALACATTA
35X70 RET.

LM-3545



× TENDER CALACATTA
35X70 RET.

P-6450

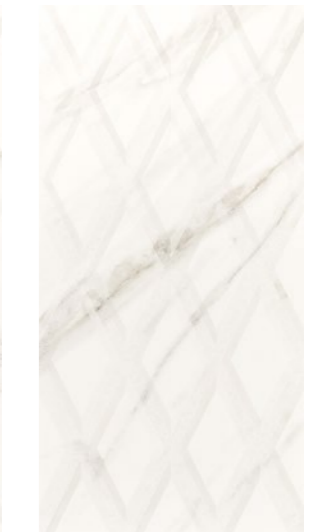

× TENDER CALACATTA MATT
35X70 RET.

P-6450

PRECIOUS



10,5 MM
TIE
HEXAGON



9,5 MM
PRECIOUS

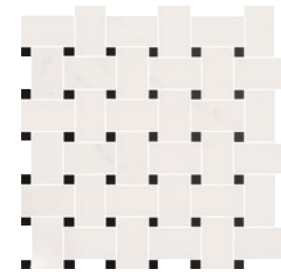

✕ MOSAIC PRECIOUS TIE CALACATTA
35X35 P-6370



MOSAIC HEXAGON MIX CALACATTA*
30,5X31 P-6370

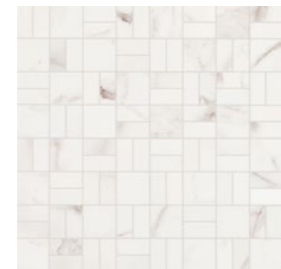

MOSAIC PRECIOUS MIX CALACATTA*
35X35 P-6350

LISTELO BRUSHED GOLD
0,5X100

P-6420

LISTELO BRUSHED SILVER
0,5X100

P-6350

LISTELO SHINE SILVER
0,5X100

P-6350

*
MOSAICO COM MISTURA DE PEÇAS BRILHO E MATE
MOSAIC MIXING GLOSSY AND MATT PIECES
MOSAÏQUE AVEC MÉLANGE DE PIÈCES FINITIONS BRILLANT ET MAT
MOSAÏK MIT EINER MISCHUNG VON GLÄNZENDE UND MATT ELEMENTE

PEÇAS ESPECIAIS // SPECIAL PIECES // PIÈCES SPÉCIALES // SPEZIALTEILE // СПЕЦИАЛЬНЫЕ ЭЛЕМЕНТЫ

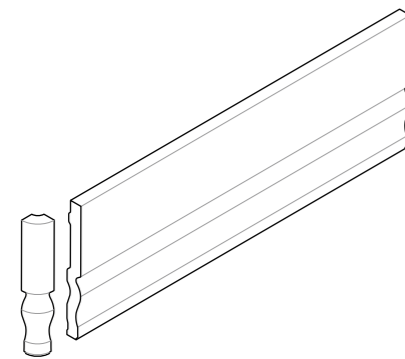

✕ ALZATA PRECIOUS CALACATTA
12,5X35 P-6340
✕ ANGOLO ALZATA PRECIOUS CALACATTA
12,5X2 P-6330

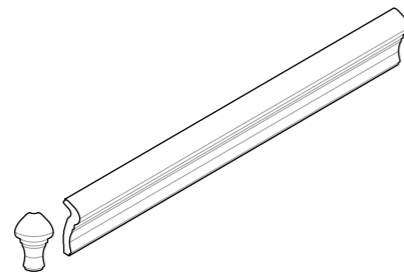

✕ TORELLO PRECIOUS CALACATTA
5X35 P-6270
✕ ANGOLO TORELLO PRECIOUS CALACATTA
5X2 P-6260

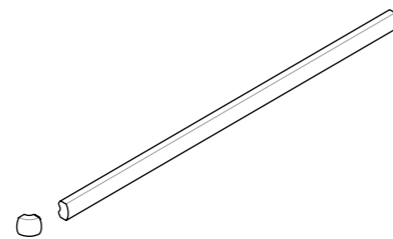

✕ MATITA PRECIOUS CALACATTA
1,5X35 P-6220
✕ ANGOLO MATITA PRECIOUS CALACATTA
1,5X2 P-6260

LOVE
CERAMIC TILES



BOXY CALACATTA 35X70 RET.

PRECIOUS

C A L A C A T T A

EMBALAGEM | PACKING | EMBALLAGE | VERPACKUNG | УПАКОВКА

FORMATO SIZE FORMAT FORMAT РАЗМЕР	PRODUTO PRODUCT PRODUIT PRODUKT ПРОДУКТ	ESPESSURA THICKNESS ÉPAISSEUR DICKE ПРОДУКТ	PEÇAS/M ² PCS/M ² STK/M ² ШТ/М ²	PESO/M ² WEIGHT/M ² POIDS/M ² GEWICHT/M ² ВЕС/М ²	PZ X	M ² X	KG X	X	M ² X	KG X	A X B X C CM
35x100	Revestimento Monoporosa Retificado White Body Wall Tiles Rectified Faïences Monocuisson Rectifiées Steingut Weisscherbe Wandfliesen Rektifiziert Облицовочная Плитка Однократного Обжига Ректифицированная	10,5 mm	2,86	17,83 Kg	3	1,05	18,72 Kg	26	27,30	512 Kg	105 x 120 x 50
35x100 SHAPE	Revestimento Monoporosa Retificado White Body Wall Tiles Rectified Faïences Monocuisson Rectifiées Steingut Weisscherbe Wandfliesen Rektifiziert Облицовочная Плитка Однократного Обжига Ректифицированная	10,5-10,8 mm	2,86	18,95 Kg	3	1,05	19,90 Kg	26	27,30	542 Kg	105 x 120 x 50
35x100 FLOW	Revestimento Monoporosa Retificado White Body Wall Tiles Rectified Faïences Monocuisson Rectifiées Steingut Weisscherbe Wandfliesen Rektifiziert Облицовочная Плитка Однократного Обжига Ректифицированная	10,5-10,8 mm	2,86	17,83 Kg	3	1,05	18,72 Kg	26	27,30	512 Kg	105 x 120 x 50
35x70	Revestimento Monoporosa Retificado White Body Wall Tiles Rectified Faïences Monocuisson Rectifiées Steingut Weisscherbe Wandfliesen Rektifiziert Облицовочная Плитка Однократного Обжига Ректифицированная	9,5	4,07	15,76 Kg	5	1,23	19,38	48	59,04	955	105 x 120 x 85
35x70 CURL	Revestimento Monoporosa Retificado White Body Wall Tiles Rectified Faïences Monocuisson Rectifiées Steingut Weisscherbe Wandfliesen Rektifiziert Облицовочная Плитка Однократного Обжига Ректифицированная	9,2-9,8 mm	4,08	15,82 Kg	5	1,23	19,38	48	59,04	955	105 x 120 x 85
59,2x59,2	Grés Vidrado Retificado Porcelain Glazed Tiles Rectified Grès Cérame Émaillé Rectifié Feinsteinzeug Glasiert Rektifiziert Керамогранит Глазурованный Ректифицированный	10,0 mm	2,85	22,50 Kg	3	1,05	23,63 Kg	36	37,80	875 Kg	80 x 120 x 74,2
8x59,2	Rodapé Vidrado Glazed Porcelain Skirting Plinthe Grès Cérame Émaillé Feinsteinzeug Glasiert Sockel Плинтус Керамогранитный Глазурованный	10,0 mm	—	—	16	—	17,03 Kg	56	—	974 Kg	80 x 120 x 72

SIMBOLOGIA | SYMBOLS | SYMBOLES | ZEICHEN | СИМВОЛИКА

	REVESTIMENTO COM ACABAMENTO MATE OU SEMI-BRILHO MATT OR SEMI-GLOSS WALL TILES FAIANÇES EN FINITION MAT OU SEMI-BRILLANT. WANDFLIESEN - MATT ODER HALBMATT OBERFLÄCHE НАСТЕННАЯ КЕРАМИЧЕСКАЯ ПЛИТКА С МАТОВЫМ ИЛИ ПОЛУ-ГЛЯНЦЕВЫМ ПОКРЫТИЕМ		REVESTIMENTO COM ACABAMENTO BRILHO GLOSSY WALL TILES FAIANÇES AVEC FINITION BRILLANT WANDFLIESEN - GLÄNZEND OBERFLÄCHE НАСТЕННАЯ КЕРАМИЧЕСКАЯ ПЛИТКА С ГЛЯНЦЕВЫМ ПОКРЫТИЕМ
	REVESTIMENTO ESTRUTURADO COM ACABAMENTO MATE OU SEMI-BRILHO MATT OR GLOSSY STRUCTURED WALL TILES FAIANÇES STRUCTURÉ EN FINITION MAT OU SEMI-BRILLANT STRUKTURIERTE WANDFLIESEN - MATT ODER HALBMATT OBERFLÄCHE НАСТЕННАЯ СТРУКТУРИРОВАННАЯ ПЛИТКА С МАТОВЫМ ИЛИ ПОЛУ-ГЛЯНЦЕВЫМ ПОКРЫТИЕМ		REVESTIMENTO ESTRUTURADO COM ACABAMENTO BRILHO GLOSSY STRUCTURED WALL TILES FAIANÇES STRUCTURÉ EN FINITION BRILLANT STRUKTURIERTE WANDFLIESEN - GLÄNZEND OBERFLÄCHE НАСТЕННАЯ СТРУКТУРИРОВАННАЯ ПЛИТКА С ГЛЯНЦЕВЫМ ПОКРЫТИЕМ
	PAVIMENTO COM ACABAMENTO BRILHO OU SATINADO FLOOR TILES WITH BRIGHT OR HONED FINISH REVÊTEMENT DE SOL AVEC FINITION BRILLANTE OU SATINÉE BODENBELAG MIT GLÄNZENDER ODER MATTER OBERFLÄCHE ПОВЕРХНОСТЬ С ГЛЯНЦЕВЫМ ИЛИ МАТОВЫМ ПОКРЫТИЕМ		PAVIMENTO COM ACABAMENTO POLIDO FLOOR TILES WITH POLISHED FINISH REVÊTEMENT DE SOL AVEC FINITION POLIE BODENBELAG MIT POLIERTER OBERFLÄCHE ПОЛИРОВАННАЯ ПОВЕРХНОСТЬ
	PRODUTO COM GRÁFICA E TONALIDADE DIFERENTE PRODUCT WITH DIFFERENT GRAPHICS AND SHADES PRODUIT AYANT UNE SÉRIGRAPHIE ET UNE TONALITÉ DIFFÉRENTE PRODUKT MIT VERSCHIEDENER GRAFIK UND TÖNUNG ИЗДЕЛИЯ РАЗЛИЧНОЙ ТЕКСТУРЫ И ОТТЕНКОВ		ESPESSURA THICKNESS ÉPAISSEUR DICKE ТОЛЩИНА
	DECORAÇÕES/PEÇAS ESPECIAIS VENDIDAS A M ² DECORATIONS/ SPECIAL PIECES SOLD PER M ² DÉCORATIONS/PIÈCES SPÉCIALES VENDUES AU M ² DEKORATIONEN/SONDERPOSTEN VERKAUFT PRO M ² ДЕКОРАЦИИ/СПЕЦИАЛЬНЫЕ ИЗДЕЛИЯ ПРОДАВАЕМЫЕ ПО М ²	COORDENAÇÃO: Marketing Love Ceramic Tiles	
	DESTONALIZAÇÃO LIGEIRA SHADAE VARIATION SLIGHT LÉGEREMENT DÉNUANCE FARBSPIEL GERING МИНИМАЛЬНЫЕ РАЗЛИЧИЯ	DESIGN E PRODUÇÃO: Viriato & Viriato, março 2017	



© COPYRIGHT GRES PANARIA PORTUGAL S.A.

OS PRODUTOS E MARCAS REFERIDOS OU REPRESENTADOS NESTE CATÁLOGO SÃO PROPRIEDADE DA GRES PANARIA PORTUGAL, S.A., ESTANDO AS MARCAS, DESENHOS, FOTOGRAFIAS OU TEXTOS DEVIDAMENTE PROTEGIDOS POR LEI. É EXPRESSAMENTE PROIBIDA A CÓPIA, IMITAÇÃO, ALTERAÇÃO, NO TODO OU EM PARTE, DE QUALQUER ELEMENTO CONSTITUTIVO OU REPRESENTATIVO DAS MARCAS, DESIGNADAMENTE PALAVRAS, SÍMBOLOS, CORES OU OUTROS, BEM COMO DOS LOGÓTIPOS, DESENHOS, LAYOUTS DE CATÁLOGO, AMBIENTES DE DESIGN OU DECORAÇÃO NELE REPRESENTADOS GRAFICAMENTE, SEM AUTORIZAÇÃO ESCRITA DA GRES PANARIA PORTUGAL, S.A.. A VIOLAÇÃO DE ALGUMA DAS DISPOSIÇÕES PREVISTAS NESTA DECLARAÇÃO PODERÁ ACARRETAR RESPONSABILIZAÇÃO CIVIL E CRIMINAL DO INFRACTOR.

ALL RIGHTS RESERVED. THE PRODUCTS AND BRANDS MENTIONED OR REPRESENTED IN THIS CATALOGUE ARE PROPERTY OF GRES PANARIA PORTUGAL, S.A., ALL BRANDS, DRAWINGS, PHOTOGRAPHS AND TEXTS ARE PROTECTED BY LAW. IT IS STRICTLY PROHIBITED TO COPY, IMITATE OR MODIFY IN ITS WHOLE OR PARTIALLY ANY ELEMENT INHERENT TO THE REPRESENTATION OF THE BRANDS, NAMELY WORDS, SYMBOLS, COLOURS OR OTHERS, AS WELL AS LOGOTYPES, DRAWINGS, CATALOGUE LAYOUT, DESIGN ATMOSPHERES OR DECORATION GRAPHICALLY REPRESENTED IN THE CATALOGUE, WITHOUT PRIOR WRITTEN CONSENT OF GRES PANARIA PORTUGAL S.A.. THE INFRINGEMENT OF THE DISPOSITIONS DEFINED IN THIS DECLARATION MAY RESULT IN THE CIVIL AND CRIMINAL RESPONSABILIZATION OF THE INFRACTOR.

LES PRODUITS ET LES MARQUES MENTIONNÉS OU REPRÉSENTÉS DANS CE CATALOGUE SONT LA PROPRIÉTÉ DE L'ENTREPRISE GRES PANARIA PORTUGAL, S.A., LES MARQUES, LES DESSINS, LES PHOTOGRAPHIES OU LES TEXTES SONT DUMENT PROTÉGÉS PAR LA LOI. TOUTE REPRODUCTION, IMITATION OU MODIFICATION PARTIELLE OU TOTALE DE MOTS, SYMBOLES, COULEURS OU AUTRES ÉLÉMENTS TOUT COMME LES LOGOTYPES, DESSINS, MISE EN PAGE DES CATALOGUES, AMBIANCES DE DESIGN OU DÉCORATION REPRÉSENTÉES AU NIVEAU GRAPHIQUE, SONT STRICTEMENT INTERDITES, SAUF SUR AUTORISATION ÉCRITE AU PRÉALABLE DE L'ENTREPRISE GRES PANARIA PORTUGAL, S.A.. LA VIOLATION D'UNE DE CES DISPOSITIONS PRÉVUES DANS CETTE DÉCLARATION SERA DE LA RESPONSABILITÉ CIVILE ET CRIMINELLE DU TRANSGRESSEUR.

DIE IN DIESEM KATALOG GENANNTE ODER DARGESTELLTEN PRODUKTE UND MARKEN SIND EIGENTUM DER GRES PANARIA PORTUGAL S.A.. DIE MARKEN, DESIGNS, ZEICHNUNGEN, FOTOGRAFIEEN UND TEXTE SIND GESETZLICH GESCHÜTZT. KOMPLLETTE ODER TEILWEISE KOPIEREN, NACHAHMUNGEN, ÄNDERUNGEN IRGENDNEINES KONSTITUTIVEN ODER REPRÄSENTATIVEN ELEMENTS DER MARKEN, NAMENTLICH WÖRTER, SYMBOLE, FARBEN ODER ANDERER ELEMENTE, SOWIE LOGOS, ZEICHNUNGEN, DESIGNS, LAYOUTS VON KATALOGEN, DESIGN- AMBIENTEN ODER IN DIESEN DARGESTELLTEN DEKORATIONEN SIND OHNE SCHRIFTLICHE GENEHMIGUNG DER GRES PANARIA PORTUGAL S.A. AUSDRÜCKLICH VERBOTEN. DIE VERLETZUNG IRGENDNEINER IN DIESER ERKLÄRUNG ANGEGBENEN BESTIMMUNGEN KANN ZU EINER ZIVIL- UND STRAFRECHTLICHEN VERFOLGUNG DES VERLETZENDEN FÜHREN.

PRODUTOS E BRENDS UPMYANUTYE ILI PREDSTAVLENNYE V DANOM KATALOGE, YVLYAYUTS SOBSTVENNOSTYU GRES PANARIA PORTUGAL, S.A., FIRMENNYE MARKI, RISUNKI, FOTOGRAFIИ ILI TEKSTY NADLEZHASHIM OBRAZOM ZASHCHISHENY ZAKONOM, ZAPREYAZAYETSЯ KOPYRIVANIYE, POPYRIVANIYE, POPYRIVKI, POLNOSTYU ILI CHASTIЧНО, LYUBOGO SOBSTAVLYAYUSHEGO ELEMENTA FIRMENNYKH MАРOK, V ТОМ ЧИСЛЕ СЛОВ, СИМВОЛОВ, ЦВЕТОВ И ДРУГИХ, А ТАКЖЕ ЛОГОТИПОВ, РИСУНКОВ, МАКЕТА КАТАЛОГА, ЕГО ОФОРМИТЕЛЬНОГО ДИЗАЙНА И СООТВЕТСТВУЮЩИХ ГРАФИЧЕСКИХ ДЕКОРАТИВНЫХ ЭЛЕМЕНТОВ, БЕЗ ПИСЬМЕННОГО РАЗРЕШЕНИЯ GRES PANARIA PORTUGAL, S.A.. НАРУШЕНИЕ ЛЮБОГО ИЗ ПОЛОЖЕНИЙ ЭТОГО ЗАЯВЛЕНИЯ МОЖЕТ ПРИВЕСТИ К ГРАЖДАНСКОЙ И УГОЛОВНОЙ ОТВЕТСТВЕННОСТИ ПРАВОНАРУШИТЕЛЯ.

The background of the entire page is a light-colored, marbled pattern, likely representing a ceramic tile design. The marbling consists of soft, flowing veins of light beige and cream, with some darker, brownish-gold veins that create a natural, organic look.

LOVE
CERAMIC TILES

Zona Industrial de Aveiro
3801-101 AVEIRO . PORTUGAL

T. (+351) 234 30 30 30
F. (+351) 234 30 30 31
lovetiles@lovetiles.com
www.lovetiles.com